

ECOLUM

LED



Lasts up to **8 years****

85%
ENERGY SAVINGS*





















FEBRUARY 2017 PRICE LIST

(Prices are subject to change without prior notice)

*Energy savings compared to standard incandescent lamp.
**Computed at 2.7 hours per day when used in the right conditions.

ECOLUM LED

LED LAMPS

LED LAMPS	Wattage	Lumen Output	Color Temperature	Dimmable	Lamp Base	Dimensions	PKG.	Suggested Retail Price
Product Description	W	Lm	K	Yes/No		(a x b x c mm)	Pcs./Ctn.	SRP
			 8,000 H		110-240V Wide Voltage	 200° Beam Angle	 80 CRI	
New! CBI203DL	3	250	6500 • Daylight	no	E27	45 x 85	40	65
CBI205DL	5	450	6500 • Daylight	no	E27	55 x 100	40	75
CBI207DL	7	600	6500 • Daylight	no	E27	55 x 100	40	90
CBI209DL	9	800	6500 • Daylight	no	E27	60 x 115	40	100
CBI211DL	11	1050	6500 • Daylight	no	E27	60 x 115	40	120
CBI213DL	13	1500	6500 • Daylight	no	E27	70 x 135	40	170
<i>*Replacement for CBI3 series</i>								
			 10,000 H		100-240V Wide Voltage	 200° Beam Angle		
CFS01T8DL09	9	750	6500 • Daylight	no	G13	25.4 x 600	20	150
CFS01T8DL18	18	1500	6500 • Daylight	no	G13	25.4 x 1200	20	190
			 10,000 H		100-240V Wide Voltage	 200° Beam Angle		
CBT511/DL09	9	750	6500 • Daylight	no	G13	43 x 610 x 31	20	200
CBT511/DL18	18	1500	6500 • Daylight	no	G13	43 x 1220 x 31	10	250
			 10,000 H		220V Operating Voltage	 200° Beam Angle		
ECBTS11/DL07	7	600	6500 • Daylight	no	G13	43 x 610 x 31	20	195
ECBTS11/DL16	16	1400	6500 • Daylight	no	G13	43 x 1220 x 31	20	245
			 10,000 H		100-240V Wide Voltage	 135° Beam Angle	 80 CRI	
New! CBTST5DL05	5	400	6500 • Daylight	no	N/A	34 x 315 x 22	25	150
CBTST5WW05	5	400	3000 • Warm White	no	N/A	34 x 315 x 22	25	150
CBTST5DL08	8	640	6500 • Daylight	no	N/A	34 x 575 x 22	25	190
CBTST5WW08	8	640	3000 • Warm White	no	N/A	34 x 575 x 22	25	190
CBTST5DL16	16	1260	6500 • Daylight	no	N/A	34 x 1175 x 22	25	265
CBTST5WW16	16	1260	3000 • Warm White	no	N/A	34 x 1175 x 22	25	265
			 20,000 H		100-240V Wide Voltage	 120° Beam Angle	 IP65 IP Rating	
New! CFL1010DL	10	700	6500 • Daylight	no	N/A	159 x 129 x 43	12	410
CFL1020DL	20	1400	6500 • Daylight	no	N/A	178 x 164 x 43	12	730
CFL1030DL	30	2100	6500 • Daylight	no	N/A	203 x 184 x 50	12	1,000
CFL1050DL	50	3500	6500 • Daylight	no	N/A	242 x 180 x 53	12	1,290
CFL1070DL	70	4900	6500 • Daylight	no	N/A	272 x 210 x 55	12	2,070

OPEN TYPE	Wattage	Dimensions	Packaging	Suggested Retail Price
Product Description	W	(a x b x c mm)	Pcs./Ctn.	SRP

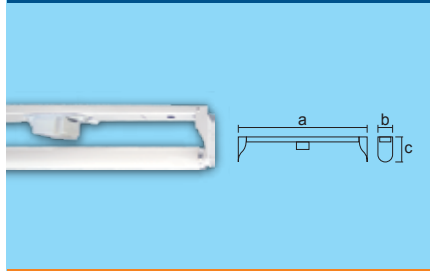

Open Type Fixture Rotary Type 220V
Operating Voltage

ESO1/10	T8	1 x 10W	350 x 48 x 90	25	150.00
ESO1/20	T8	1 x 20W	610 x 48 x 90	25	175.00
ESO1/40	T8	1 x 40W	1220 x 48 x 90	25	185.00

Fixture with Ballast & Starter

BOX TYPE

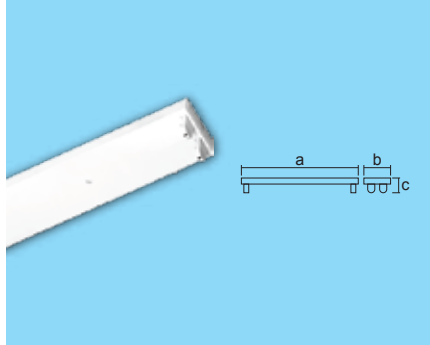

Box Type Fluorescent Fixture for Straight FL Tube 220V
Operating Voltage

EXB20	T8	1 x 20W	640 x 54 x 80	16	195.00
EXB40	T8	1 x 40W	1250 x 54 x 80	16	245.00

Fixture with Ballast & Starter

ELSFBT2X20/0	T8	2 x 20W	640 x 100 x 80	10	225.00
ELSFBT2X40/0	T8	2 x 40W	1250 x 100 x 80	10	275.00

Fixture Only

LOUVERS

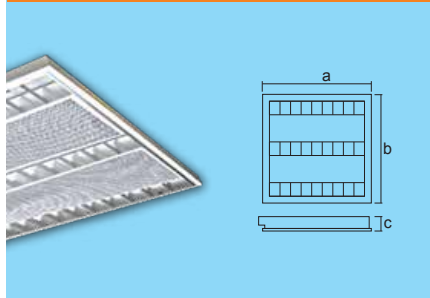

Wide Recessed Type with Aluminum Reflector 240V
Operating Voltage

ESLR2X14/1	T5	2 x 14W	600 x 600 x 80		1,299.95
ESLR3X14/1	T5	3 x 14W	600 x 600 x 80		1,999.95
ESLR2X28/1	T5	2 x 28W	1200 x 600 x 80		1,929.95
ESLR3X28/1	T5	3 x 28W	1200 x 600 x 80		3,089.95

Fixture with Electronic Ballast

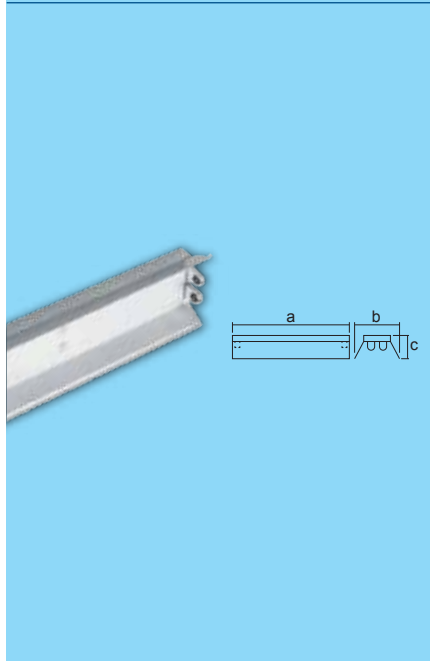

Industrial Type with Aluminum Reflector 220V
Operating Voltage

ESLIA2x20/1	T8	2 x 20W	640 x 190 x 80	2	690.00
-------------	----	---------	----------------	---	---------------

Fixture with Ballast & Starter

ESLIA1x20/0	T8	1 x 20W	640 x 135 x 80		210.00
ESLIA1x40/0	T8	1 x 40W	1250 x 135 x 80		300.00
ESLIA2x20/0	T8	2 x 20W	640 x 190 x 80		300.00
ESLIA2x40/0	T8	2 x 40W	1250 x 190 x 80		400.00

Fixture Only

Industrial Type with Powder Coated Reflector

ESLI1X20/0	T8	1 x 20W	640 x 135 x 80	12	175.00
ESLI1X40/0	T8	1 x 40W	1250 x 135 x 80	12	240.00
ESLI2X20/0	T8	2 x 20W	640 x 190 x 80	7	260.00
ESLI2X40/0	T8	2 x 40W	1250 x 190 x 80	7	340.00

Fixture Only

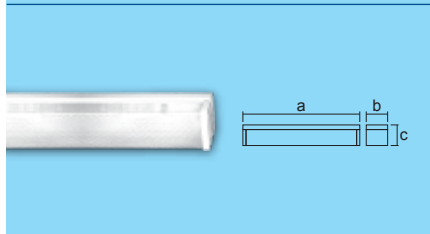

Prismatic Type Magnetic for Straight FL Tube 220V
Operating Voltage

ELSSPL1X40/0	T8	1 x 40W	1260 x 90 x 80	6	540.00
ELSSPL2X40/0	T8	2 x 40W	1237 x 177 x 65	4	620.00

Fixture Only

LOUVERS	Wattage	Dimensions	Packaging	Suggested Retail Price
Product Description	W	(a x b x c mm)	Pcs./Ctn.	SRP

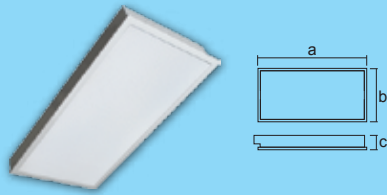

Recessed Type Dust Proof Louver

ELSRDP1X20/0	T8	1 x 20W	600 x 300 x 80	2	700.00
ELSRDP1X40/0	T8	1 x 40W	1200 x 300 x 80	2	750.00
ELSRDP2X20/0	T8	2 x 20W	600 x 300 x 80	2	750.00
ELSRDP2X40/0	T8	2 x 40W	1200 x 300 x 80	2	850.00

Fixture Only

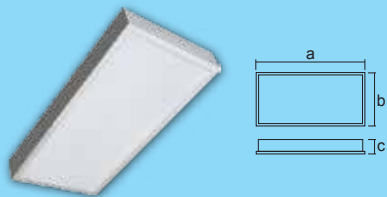

Surface Type Dust Proof Louver

ELSSDP1X20/0	T8	1 x 20W	610 x 190 x 80	2	700.00
ELSSDP1X40/0	T8	1 x 40W	1220 x 190 x 80	2	750.00
ELSSDP2X20/0	T8	2 x 20W	610 x 310 x 80	2	750.00
ELSSDP2X40/0	T8	2 x 40W	1220 x 310 x 80	2	850.00

Fixture Only

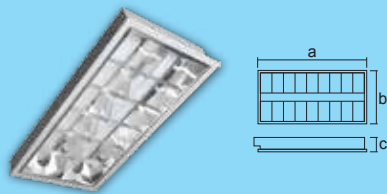

Recessed Type with Aluminum Reflector

ESLR1X20/0	T8	1 x 20W	600 x 190 x 80	2	620.00
ESLR1X40/0	T8	1 x 40W	1200 x 190 x 80	2	720.00
ESLR2X20/0	T8	2 x 20W	600 x 300 x 80	2	630.00
ESLR2X40/0	T8	2 x 40W	1200 x 300 x 80	2	790.00
ESLR3X20/0	T8	3 x 20W	600 x 600 x 80	2	930.00
ESLR3X40/0	T8	3 x 40W	1200 x 600 x 80	2	1,590.00

Fixture Only

Wide Recessed Type with Aluminum Reflector

ESLRW1X20/0	T8	1 x 20W	600 x 300 x 80	2	670.00
ESLRW1X40/0	T8	1 x 40W	1200 x 300 x 80	2	820.00
ESLRW2X20/0	T8	2 x 20W	600 x 600 x 80	2	780.00
ESLRW2X40/0	T8	2 x 40W	1200 x 600 x 80	2	1,290.00

Fixture Only

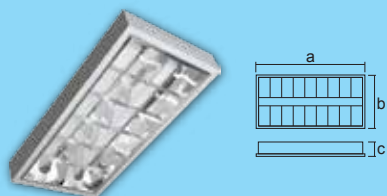

Surface Type with Aluminum Reflector

ESLS1X40/0	T8	1 x 40W	1220 x 190 x 80	2	720.00
ESLS2X20/0	T8	2 x 20W	610 x 310 x 80	2	630.00
ESLS2X40/0	T8	2 x 40W	1220 x 310 x 80	2	790.00
ESLS3X20/0	T8	3 x 20W	610 x 610 x 80	2	930.00







Fixture Only

Wide Surface Type with Aluminum Reflector

ESLSW1X20/0	T8	1 x 20W	610 x 310 x 80	2	670.00
ESLSW1X40/0	T8	1 x 40W	1220 x 310 x 80	2	820.00

Fixture Only

HAND-HELD FLASHLIGHTS			PKG.	Suggested Retail Price	HAND-HELD FLASHLIGHTS			PKG.	Suggested Retail Price	
Product Description			Pcs./Ctn.	SRP	Product Description			Pcs./Ctn.	SRP	
	Handy Torch Light					Handy Torch Light				
	EEL541R (Red)	20	95.00	EEL542		60	170.00			
	<ul style="list-style-type: none"> • 230V 50/60Hz • Hi-Power LED • 4V 400mAh Sealed Lead Acid • Charging Time: 12 - 15 Hrs. • Duration Time: <ul style="list-style-type: none"> 10 Hrs. = Low Torch 2.5 Hrs. = High Torch 					<ul style="list-style-type: none"> • 230V 50/60Hz • 3 Watts Hi-Power LED • 4V 900mAh Sealed Lead Acid • Charging Time: 12 - 15 Hrs. • Duration Time: 4 Hrs. = Low Torch 1 Hr. = High Torch 				
	Handy Torch Light					7 LED Mega Torch Lamp				
	EEL541G (Green)	20	95.00	EEL543		56/1	240.00			
	<ul style="list-style-type: none"> • 230V 50/60Hz • Hi-Power LED • 4V 400mAh Sealed Lead Acid • Charging Time: 12 - 15 Hrs. • Duration Time: <ul style="list-style-type: none"> 10 Hrs. = Low Torch 2.5 Hrs. = High Torch 					<ul style="list-style-type: none"> • 220 - 240V AC 50/60Hz • 7 x 1500mcd 110° LED • 4V 400mAh Sealed Lead Acid • Charging Time: 12 - 15 Hrs. • Duration Time: 3 Hrs. = Torch 				
	Handy Torch Light					9 LED Mega Torch Lamp				
	EEL541B (Blue)	20	95.00	EEL544		48/1	320.00			
	<ul style="list-style-type: none"> • 230V 50/60Hz • Hi-Power LED • 4V 400mAh Sealed Lead Acid • Charging Time: 12 - 15 Hrs. • Duration Time: <ul style="list-style-type: none"> 10 Hrs. = Low Torch 2.5 Hrs. = High Torch 					<ul style="list-style-type: none"> • 220 - 240V AC 50/60Hz • 9 x 1500mcd 110° LED • 4V 1Ah Sealed Lead Acid • Charging Time: 12 - 15 Hrs. • Duration Time: 5 Hrs. = Torch 				
	Handy Torch Light					12 LED Mega Torch Lamp				
	EEL541Y (Yellow)	20	95.00	EEL545	40/1	360.00				
<ul style="list-style-type: none"> • 230V 50/60Hz • Hi-Power LED • 4V 400mAh Sealed Lead Acid • Charging Time: 12 - 15 Hrs. • Duration Time: <ul style="list-style-type: none"> 10 Hrs. = Low Torch 2.5 Hrs. = High Torch 				<ul style="list-style-type: none"> • 220 - 240V AC 50/60Hz • 12 x 1500mcd 110° LED • 4V 1Ah Sealed Lead Acid • Charging Time: 12 - 15 Hrs. • Duration Time: 4 Hrs. = Torch 						

EXIT LIGHTS	Lamp	Charging Time	Usage Duration	Color	PKG.	Suggested Retail Price		
Product Description		Hours	Minutes		Pcs./Ctn.	SRP		
	4 LED Exit Light Milled Aluminum Type Double-sided Face 1.2V, 600mAh Rechargeable Ni-Cd Battery		220V AC Operating Voltage					
		EEL211	4 x 1500mcd 110° LED	24 Hrs.	90 Minutes	• Green	20	650.00
		EEL212	4 x 1500mcd 110° LED	24 Hrs.	90 Minutes	• Green	20	650.00
		EEL213	4 x 1500mcd 110° LED	24 Hrs.	90 Minutes	• Green	20	650.00
		EEL214	4 x 1500mcd 110° LED	24 Hrs.	90 Minutes	• Green	20	650.00
		EEL215	4 x 1500mcd 110° LED	24 Hrs.	90 Minutes	• Green	20	650.00
		EEL216	4 x 1500mcd 110° LED	24 Hrs.	90 Minutes	• Green	20	650.00

FIREFLY ELECTRIC & LIGHTING CORP.

7/F Zen Offices Bldg. 1111 Natividad Lopez St., Ermita, Manila, Philippines
 T: (02) 7891000 (Trunkline)
 www.fireflyelectric.com • info@fireflyelectric.com

Contact Person: